

SCALE
20=1

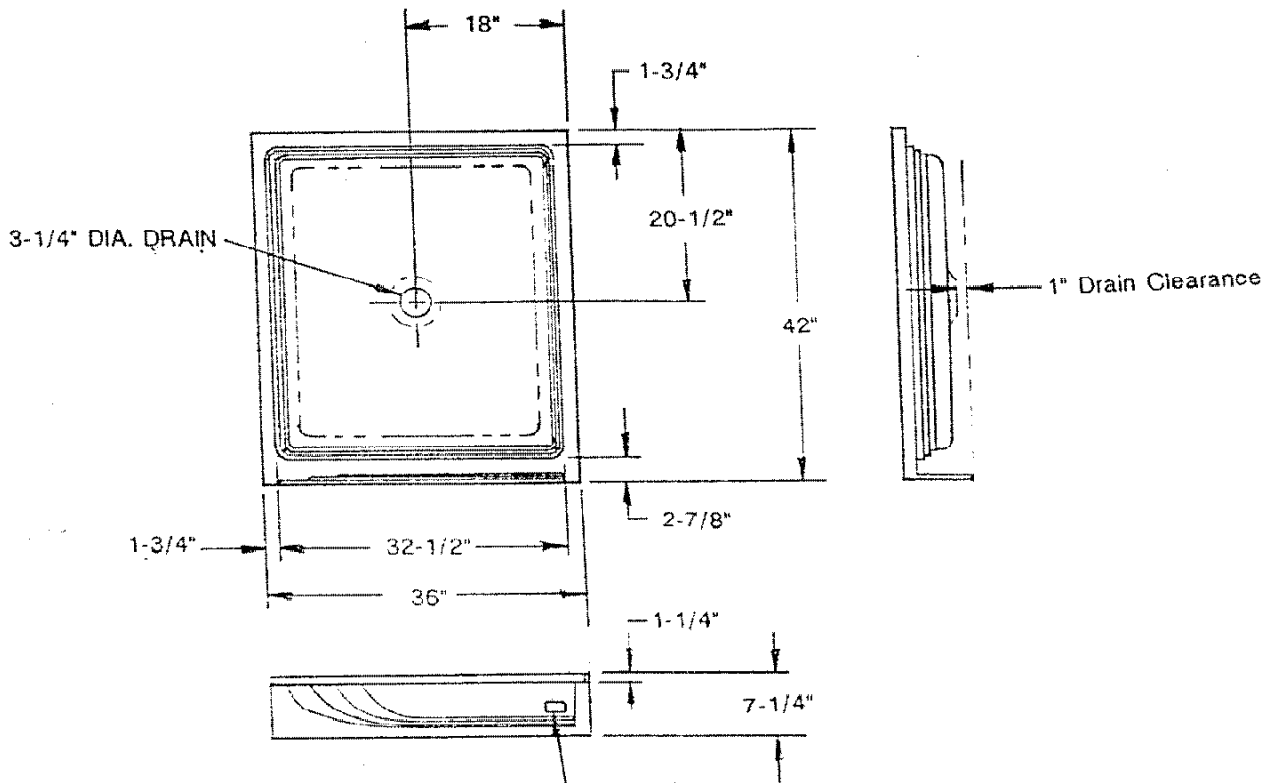

LASCO
BATHWARE

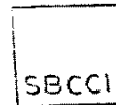

3642-APAN

APPROVAL LABEL

LASCO
BATHWARE

ACRYLIC SHOWER PAN
MODEL 3642-APAN

7/99